

Images Scientific Instruments Inc.
109 Woods of Arden Road
Staten Island NY 10312
718.966.3694 Tel
718.966.3695 Fax
www.imagesco.com

Construction Manual and Users Guide Model GCK-01-01 Analog Geiger Counter

Features:

Detects: Alpha, Beta, Gamma and X-Rays.

Alpha radiation above 3.0 MeV

Beta radiation above 50 KeV

Gamma radiation above 7 Ke

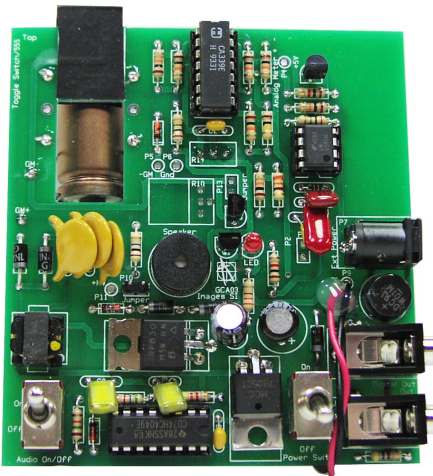

Digital Output -- The digital output jack provides a TTL logic high pulse each time a radioactive particle is detected. The digital output may be interfaced to a Personal computer (PC) or a microprocessor using our DMAD - Digital Meter Adapter. Free Windows based radiation monitor and charting programs available.

External Power Jack

Headphone Jack

Standard Output -- Geiger Counter clicks and blinks an LED each time a radioactive particle is detected.

GCK-01-01 Analog Geiger Counter Kit

Table of Contents

- The Geiger Counter.....3**
- Radioactivity.....3**
- Geiger Tube.....4**
- Count Rate vs. Dose Rate.....5**
- Finding Radioactive Sources.....6**
- Check Out.....6**
- Background Radiation.....6**
- Separating & Detecting Beta and Gamma.....6**
- Features.....7**
- Schematic.....8**
- Circuit Construction.....9**
- Testing the HV Section.....10**
- Continuing Construction.....11**
- Internal Tube.....12**
- For External Wands.....13**
- Testing before Continuing General Construction..14**
- Installing/Changing the Battery.....14**
- GCK-01-01 Parts List.....15**

The Geiger Counter

Geiger Counters are instruments that can detect and measure radioactivity. H. Geiger and E.W. Muller invented the Geiger counter in 1928.

When you are finished building your Geiger Counter kit you can use it to check materials and environment for radioactivity. Geiger counters are useful in performing experiments with radioactivity and nuclear energy. You could even go prospecting for uranium, if you desire.

Radioactivity

Radioactivity is the spontaneous emission of energy from the nucleus of certain elements, most notably uranium. There are three forms of energy associated with radioactivity; alpha, beta and gamma radiation. The classifications were originally made according to the penetrating power of the radiation.

Alpha rays were found to be the nuclei of helium atoms, two protons and two neutrons bound together. Alpha rays have a net positive charge. Alpha particles have weak penetrating ability; a couple of inches of air or a few sheets of paper can effectively block them.

Beta rays were found to be electrons, identical to the electrons found in atoms. Beta rays have a net negative charge. Beta rays have a greater penetrating power than Alpha rays and can penetrate 3mm of aluminum.

Gamma rays are high-energy photons. This has the greatest penetrating power being able to pass through several centimeters of lead and still be detected on the other side.

Images Geiger Counter Model GCK-01-01 is sensitive to all three types of radioactivity.

Geiger Tube

The Geiger Mueller (GM) tube hasn't changed much since it was

invented in 1928. The operating principle is the same. A cutaway drawing of the tube is shown in figure 1. The wall of the GM tube is a thin metal cylinder (cathode) surrounding a center electrode (anode). It is constructed with a thin Mica window on the front end. The thin mica window allows the passage and detection of alpha particles. The tube is evacuated and filled with Neon, Argon plus Halogen gas.

It is interesting to see how the GM tube detects radioactivity. A 500-volt potential is applied to the anode (center electrode) through a ten mega-ohm current limiting resistor. To the cathode of the tube a 460-k ohm resistor is connected.

Figure 1

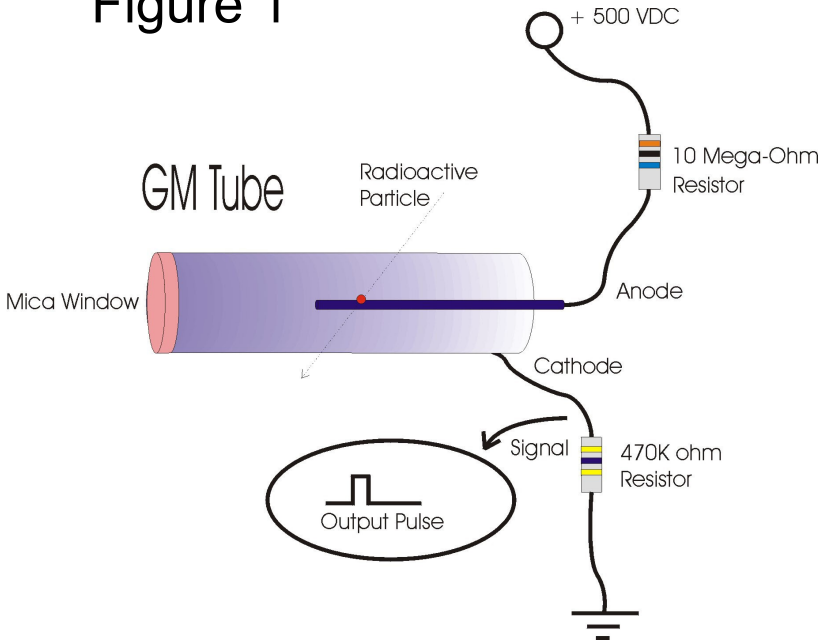

In the initial state the GM tube has a very high resistance. When a particle passes through the GM tube, it ionizes the gas molecules in its path. This is analogous to the vapor trail left in a cloud chamber by a particle. In the GM tube, the electron liberated from the atom by the radioactive particle and the positive ionized atom both move rapidly towards the high potential electrodes of the GM tube. In doing so they collide with and ionize other gas atoms. This creates a small conduction path allowing a momentary surge of electric current to pass through the tube.

This momentary pulse of current appears as a small voltage pulse across R2. The halogen gas quenches the ionization and returns the GM tube to its high resistance state making it ready to detect radio-activity.

Count Rate Vs Dose Rate

Each output pulse from the GM tube is a count. The counts per second give an approximation of the strength of the radiation field. Below is the approximate GM tube's response to a cesium-137 source, shown in figure 2.

Features:

GMT Tube

The GCK-01-01 features the GMT-01 (LND 712)

Count rate vs. Dose rate (Cs-137)

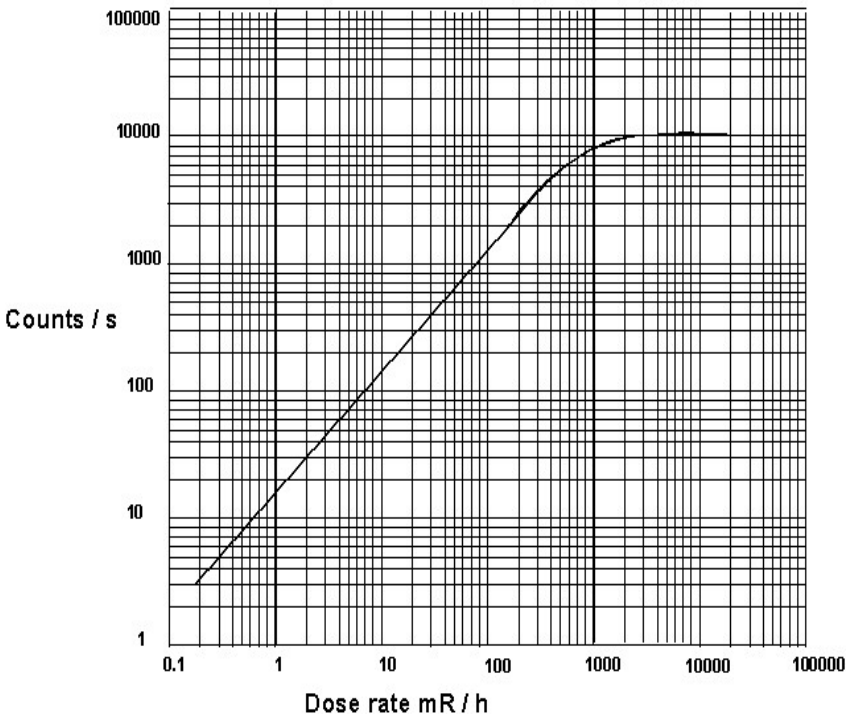

Figure 2

A more reliable source is to purchase a radioactive source. Small amounts of radioactive materials are available for sale encased in 1 inch diameter by $\frac{1}{4}$ " thick plastic disks. The disks are available to the general public license exempt. This material outputs radiation in the micro-curie range and has been deemed by the Federal government as safe.

The cesium-137 is a good gamma ray source. The cesium 137 has a half-life of 30 years.

Check Out

Turn on the Geiger counter. If you have a radiation source bring the GM tube close to it. The radiation will cause the Geiger counter to start clicking. The LED will pulse with each click. Each click represents the detection of one of the radioactive rays; alpha, beta or gamma.

Background Radiation

Background radiation, from natural sources on earth and cosmic rays will cause the Geiger counter to click. In my corner of the world I have a background radiation that triggers the counter 12-20 times a minute.

Separating & Detecting Beta and Gamma

By placing shields of different materials in front of the GM tube we can filter out some radiation. For instance placing a paper shield in front of the GM tube will block all the Alpha radiation. The Geiger counter will now only detect beta and gamma radiations.

If we place a thin metal shield in front of the GM tube that would effectively block the alpha and beta radiation, allowing the detection of gamma radiation.



The Geiger-Mueller tube (GMT-01), is Ne + Halogen filled, with a .38" effective diameter 1.5-2.0 mg/cm² mica end window.

Data Output

The data output jack may be used for an analog meter. The analog meter is an accessory that plugs into the data output jack and provides a visual indication of the approximate radiation level. The data output provides a TTL logic (+5V) pulse every time the Geiger counter detects radiation. This signal can easily be connected to a microcontroller or PC. The PC or microcontroller can then be used to create a digital Geiger counter, chart recorder or other recording instrument for nuclear experiments.

External Power Jack

The GCK-01-01 may be powered by either a 9-Volt battery or external power source with a 2.5mm jack.

Head Phone Jack

When using the headphone jack for headphones the speaker is automatically cut-off.

Finding Radioactive Sources

The mantle in some Coleman lanterns are radioactive. Bring your Geiger counter to a local hardware store and check them out.

Uranium ore from a mineral or a rock store should also emit sufficient radiation to trigger the counter.

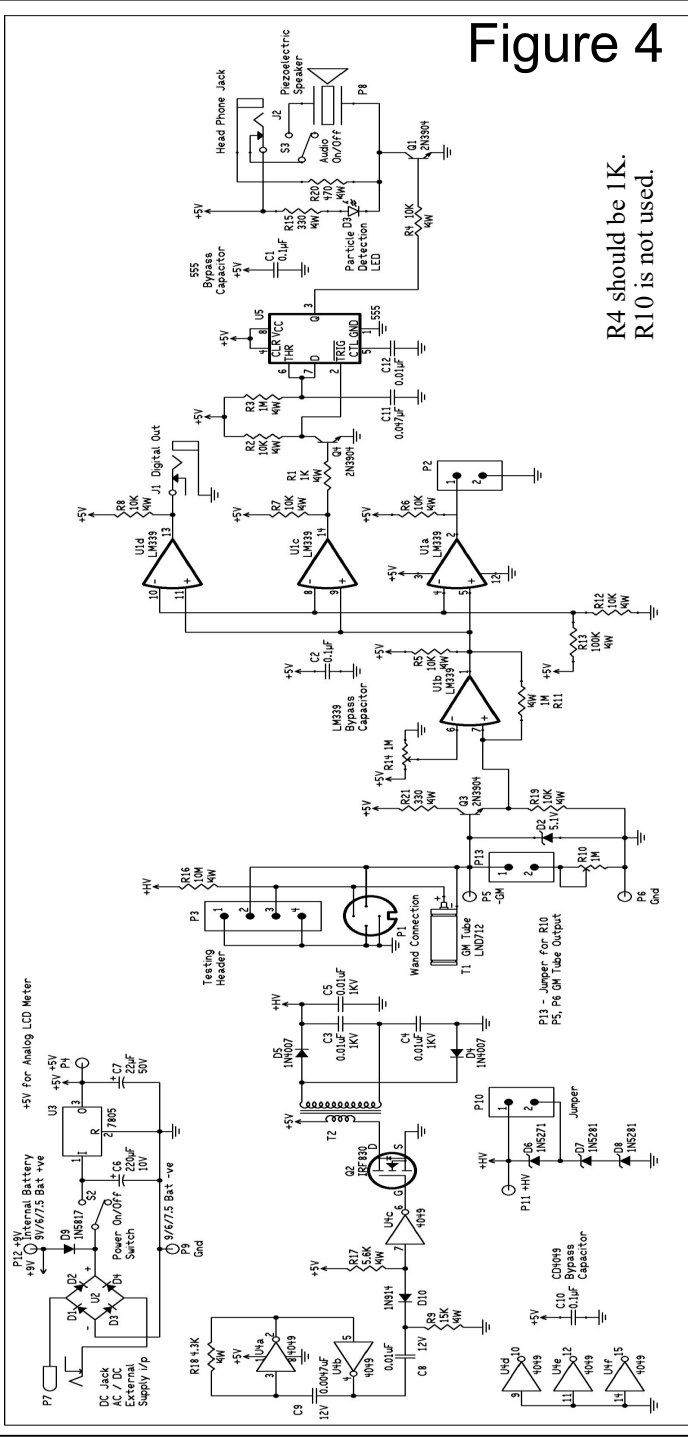
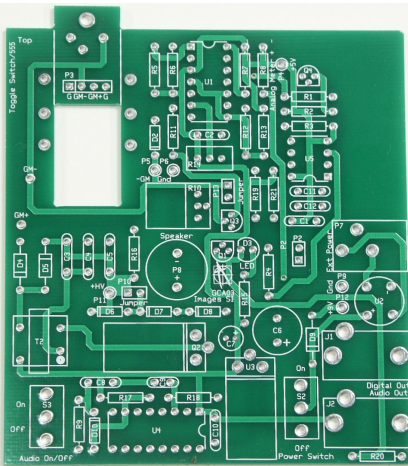

Figure 4

R4 should be 1K.
R10 is not used.

5V regulator 7805 shown in circuit, MIC29405 is actually used



5A. PCB for GMT-02 & external wand

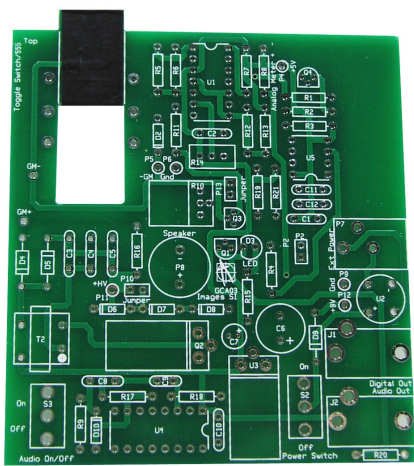

5B. PCB for LND712 (GMT-01)

Figure 5

Circuit Construction

The schematic for the GCK-01-01 is shown in Figure 4. The top silkscreen of the PCB is shown in Figure 5.

Before beginning construction, it is important to decide if you will be using an external wand or attaching the GM tube directly to the PC Board. If you are attached the GM tube directly to the PCB, we must insulate a section of the board to prevent it from shorting out. To do this peel the backing from the included piece of vinyl and wrap and wrap it around the section of the pcb located above the cutout. Begin on the back of the pcb at the top of the opening, wrap it around the top of the pcb and back through the opening. This area is marked with 2 lines on the front of the pcb and shown in black in Figure 5B.

Begin construction by soldering resistors R17 5.6K (color bands green, blue, red), R18 4.3K (color bands yellow, orange, red) and R9 15K (color bands brown, green, orange). Next we will wire the square wave generator and pulse shaping circuit using the ICS-16 socket for the 4049, marked U4 on PCB. Insert the ICS-16, making sure to orient the notch on socket to the drawing on the PCB and solder to the board.

Place and solder components C8 (.01uf), C9 (.0047uf), C10, (.1uf) and D10 (1N914). Now construct the high voltage section consisting

of the step up transformer T2, diodes D4 & D5 (1N4007) and capacitors C3, C4 and C5 (.01uf 1KV). Mount IRF830 transistor Q2 to the PCB, bend the transistor outward so it lays flat on the PCB, see Figure 6, and solder.

To this add the 5 volt 7805 regulator (U3), bending it outward so it lays flat as with transistor and solder into position. Next mount and solder capacitors C6 (220uf-330uf), C7 (22uf), and diode D9

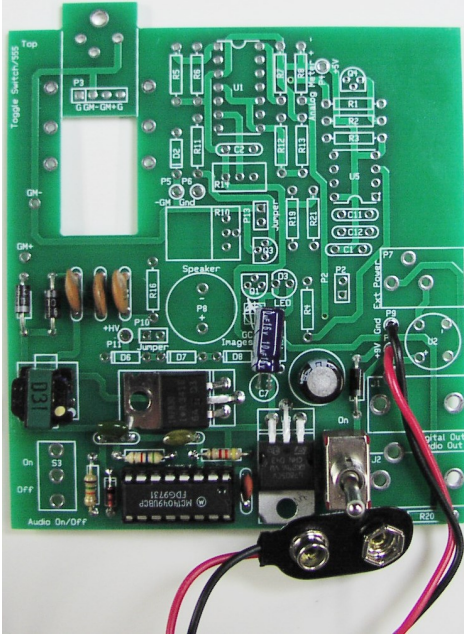

Figure 6

(1N5817). Place and solder the 9-volt battery cap on the PC board. The red lead connects to the positive terminal P12. The black lead connects to GND, marked P9. Solder the power switch to the PCB at S2. Insert 4049 into the socket, making sure to orient the notch on the chip to the notch on the socket.

Testing HV Section

CAUTION: Circuit generates high voltage power that can provide an electrical shock. Exercise caution when working around the high voltage section of the circuit. The capacitors C4 and C5 can hold a HV charge after the circuit has been shut off.

To check the HV power supply; turn the power switch off. Insert the 9-volt battery onto the battery cap. Set up a VOM to read 500 to 1000 volts. Place the positive lead of the VOM at P11. The negative lead of the VOM is connected to the—(negative) terminal of the 9-Volt battery.

Apply power to the circuit using the power switch, The circuit should generate anywhere between 550 and 800 volts (depending upon component tolerances) If you are reading between 550 and 800 volts, fine, turn off the power. Add the three zener diodes; D6 (100V) and D7 & D8 (200V). Attach a 2-pin header at P10. Apply power again, with the positive lead of the VOM still attached to P11; you should read a voltage of 500 volts. If you're not getting a proper voltage reading, check the zener diodes to make sure you have them orientated in the right direction.

Continuing Construction

Finish the construction of the circuit by adding the ICS-8 for the 555 timer and the ICS-14 for the LM339. Again, be sure to align the notch on the socket and chips with the silkscreen on the PCB. Mount and solder all remaining resistors; R1 & R4 are 1K resistors (color bands brown, black, red). R2, R5-R8, R12 & R19 are 10K resistors (color bands brown, black, orange). R3 & R11 are 1 Meg resistors (color bands brown, black, green). R13 is a 100K resistor (color bands brown, black, yellow). R15 & R21 are 330 ohm resistors (color bands orange, orange, brown). R16 is a 10 Meg resistor (color bands brown, black, blue), and R20 is a 470 ohm resistor (color bands yellow, purple, brown).

Next mount and solder capacitors C1 & C2 (.1uF), C11 (.047uF) and C12 (.01uf). Mount and solder the 1 Meg, 25-turn potentiometers (R14) on the underside of the board.

Now mount and solder the 5.1V zener diode (D2), the Audio switch, power jack, headphone jack and digital output jack. Mount and solder the speaker, transistors Q1, Q3 & Q4 (2N3904), 2-pin headers (P2) and LED (the longer of the LED terminals is positive (+)) to the PCB. The LED should rise 3/8" from the PCB to the bottom of the LED. This distance will insure proper placement of the LED when the PCB is mounted inside the case.

Mount and solder the bridge rectifier making sure to align the + terminal of the rectifier to the + terminal on the PCB. At this point your Geiger counter pc board should look like Figure 7 without the GM tube.

The Geiger Muller tube has two leads. It is mounted on the bottom side of the PCB. The wire connected to the metal sides of the tube is the negative terminal. This is soldered to the (-) GM terminal on the

PC board. The center terminal of the GM tube has a removable solder lead. Remove the lead, solder 1.5” of wire to and. Reattach the lead to the center terminal of the GM tube. Take the opposite end of the wire and solder to the (+) GM terminal on the PC board.

Figure 7

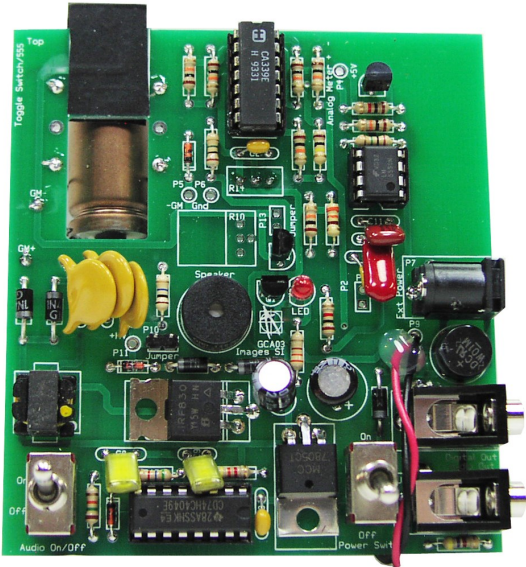

Internal Tube

The Geiger Mueller tube is delicate and needs to be protected in an enclosure. However the enclosure has a 1/2” hole that allows the front surface (mica window) of the GM tube to remain exposed. This way alpha particles can pass through the thin mica window and be detected.

After securing with a wire, as in Figure 8, a small amount of glue or epoxy can be dabbed on the wire tube assembly for added support. Before mounting the PCB inside the case, check to make sure the entire Geiger Counter circuit functions. To do this you may use either our Digital Meter Adapter (DMAD-04) or Analog/Digital Meter (ADM-01). The DMAD-04 plugs into the Digital Output (J1) of the GCK-01. The ADM-01 is connect to the PCB using the wiring diagram found in the ADM-01 Manual.

Calibrating your GCK-01-01 Using an ADM-01 or DMAD-04 Meter

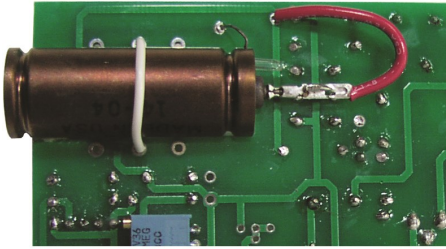

Figure 8

For External Wands



The anode
GM Tube
within the wand.

resistor for the
is housed

Attach and solder the 8-pin min-din connector to the underside of the PCB as shown in Figure 9 below.

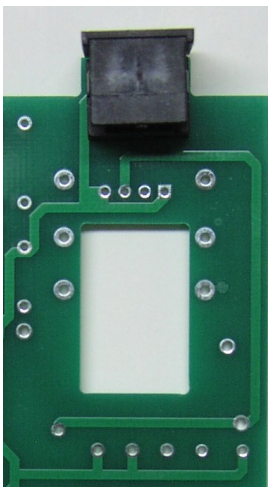

Figure 9

Caution: Plugging or unplugging the GM wand (GCW-01) while the Geiger counter is on may damage the circuit. This damage is not covered under warranty.

We can use a simple procedure to get an approximate calibration for the analog/digital meter. The difficulty in calibrating the meter has much to do with the variables in play. The tube's response can vary +/- 20 %. The strength of the radioactive source can also vary in addition to variations in our electronic components. All these factors affect accuracy. With this being said, we can proceed to get that approximation for our Geiger counter.

Our calibration procedure uses a 10 uCi CS-137 source. Any radioactive material (see Finding Radioactive Sources) may be used for this procedure. To begin hold your radioactive source against the GM tube as close as possible. You may need to use a rubber band or tape to hold the source in place. Adjust the potentiometer at R14 until you obtain the highest possible CPS (Counts per Second) reading on the meter.

Now remove the radioactive source and move it away from the GM tube to the point that it no longer affects the meter readings. Check background radiation. Normal background radiation for our facility ranges from 15-35 CPM; background radiation levels vary from location to location and are dependent on a variety of factors. A simple internet search of "normal background radiation levels" with your location will provide you with data specific to you.

While checking for background radiation, you should also check that the meter is reading single pulses. If you are getting double pulses the majority of the time, turn the potentiometer down. If you are consistently getting high background readings, check that your radioactive source has been placed out of range and then turn the potentiometer until you have reached acceptable norms.

When you are satisfied that the circuit is working properly, it can now be mounted in a suitable housing. The following instructions are for mounting inside Images SI's Analog Geiger Counter Case.

Mount the PC board to the front of the case. The shafts of the two PC mounted switch and LED should fit into the pre-drilled holes. The PCB is held to the case front using the two nuts to the PC mounted switches.

Finish by placing the 9-volt battery cap into the battery compartment of the back case. Close the case and secure with case screws.

Installing /Changing Battery

To install or change battery open battery compartment on the back of the Geiger counter and install or replace battery, see Figure 10.

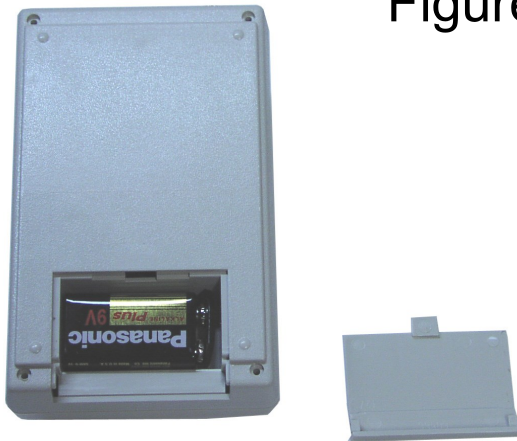

Figure 10

GCK-01-01 Parts List

(1) PCB-66	D6	1N5271 Diode 100V Zener (1)
(1) GMT-01	D7, D8	1N5281 Diodes 200V Zener (2)
(1) self adhesive black vinyl strip	D9	1N5817 Diode (1)
R1, R4 1K 1/4W Resistor (2)	D10	1N914/1N514 Diode (1)
R2, R5, R6, R7, R8, R12, R19	U1	LM339 (1)
10K 1/4W Resistors (7)		14 pin socket (1)
R9 15K 1/4W Resistor (1)	U2	W01M - Bridge Rectifier (1)
R3, R11 1 Mega Ohm 1/4W Resistor (2)	U3	7805 Voltage Regulator (1)
R13 100K 1/4W Resistor (1)	U4	4049 (1)
R15, R21 330 Ohm 1/4W Resistors (2)		16 pin socket (1)
R16 10 Mega Ohm 1/4W Resistor (1)	U5	LM555 Timer (1)
R17 5.6K 1/4W Resistor (1)		8 pin socket (1)
R18 4.3K 1/4W Resistor (1)	Q1, Q3, Q4	
R20 470 Ohm 1/4W Resistor (1)		2N3904 Transistors (3)
R14 1 Meg 25-Turn Pot. (1)	Q2	IRF830 (1)
C1, C2, C10	J1, J2	Jack-05 Audio Jack (2)
0.1uF 50V Capacitors (3)	P2, P10	2 pin headers (2)
C3, C4, C5	P7	PJ-102B power jack (1)
0.01uf 1KV Capacitors (3)	P8	SPK-05 speaker (1)
C6 220uF 10V Capacitor (1)	S2, S3	SW-07 toggle switches (2)
C7 22uF 50V Capacitor (1)	T2	HVT-03 transformer (1)
C8, C12 0.01uf 12V Capacitors (2)	P9, P12	BAT-01 battery clip (1)
C9 0.0047uf 100V Capacitor (1)		
C11 0.047uF Capacitor (1)		
		Additional parts included for alternate configurations.
D2 1N751 5.1V Zener Diode (1)		
D3 Red Subminiature LED (1)		
D4, D5 1N4007 Diodes (2)		